

BK2016-A

Drawn cup needle roller bearing closed end

Schaeffler ID:
0001770590000

Drawn cup needle roller bearings with
closed end BK, to DIN 618/ISO 3245

Technical information

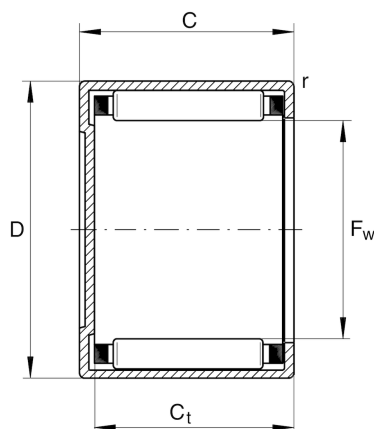

Main Dimensions & Performance Data

F_w	20 mm	Under roller diameter
D	26 mm	Outside diameter
C	16 mm	Width, outer ring
C_r	12,700 N	Basic dynamic load rating, radial
C_{0r}	20,100 N	Basic static load rating, radial
C_{ur}	2,550 N	Fatigue load limit, radial
n_G	12,700 1/min	Limiting speed
$n_{G \text{ Grease}}$	7,600 1/min	Limiting speed for grease lubrication
n_{gr}	9,300 1/min	Reference speed
	21.825 g	Weight

Additional information

r_{\min}	0.8 mm	Minimum chamfer dimension
	SD20X26X4	Sealing ring
$C_{t \min}$	13.3 mm	Minimum width to base of drawn cup with closed end
	G20X26X4	Sealing ring 2
	LR17X20X16,5	Suitable inner rings LR
	IR17X20X16-XL	Suitable inner rings IR

Temperature range

T_{\min}	-30 °C	Operating temperature min.
T_{\max}	140 °C	Operating temperature max.